



progetto 20

Greenhouse Facilities  20





progetto20 Srl sviluppa e realizza impianti ed articoli dedicati alla produzione e/o esposizione dei prodotti dell'ortoflorovivaismo. Il know-how di **progetto20** è basato sulla competenza dello staff tecnico e sull'esperienze vissute assieme ai clienti con i quali viene instaurato un rapporto di scambio e di accrescimento reciproco che si finalizza nella realizzazione di impianti, macchine e prodotti ad alto profilo tecnologico,



progetto20 Srl develops creating systems and elements dedicated to the production and/or exhibition of hortiflor nursery products. The knowledge of the **progetto20** is based on the experience of the technical personnel and on the experiences lived together with the clients with whom an association relationship of exchange and mutual growth is established that materializes in the construction of plants, machines and high-tech products.

Serie Bench

Gamma di bancali da esposizione per Garden Center e punti vendita **interamente realizzati in alluminio** completi di vasca Danese S&P e valvola a sfera per carico / scarico, forniti in kit di montaggio. Disponibili in Pronta consegna nelle dimensioni sotto indicate. Ampia possibilità di personalizzazione.

Bench Series

Range of display tables for Garden Centers and points of sale entirely **made of aluminum** complete with Danish S&P tray and ball valve for loading/unloading, supplied in mounting kits. Available for immediate delivery in the following sizes indicated. Wide possibility of customization.

STANDARD MOD. ATLANTIS:

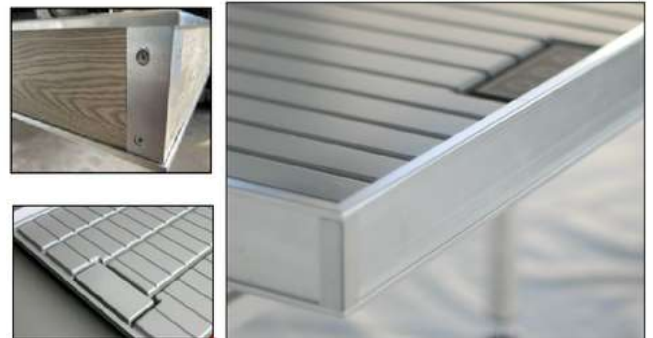
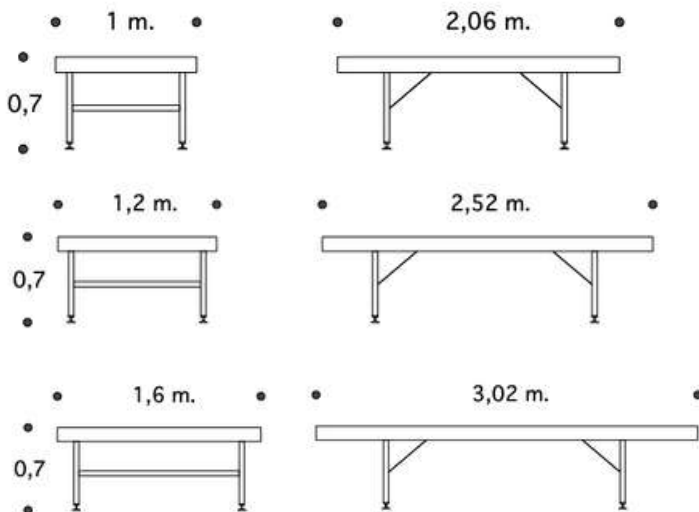

• Garden project



• Altre dimensioni a richiesta / Other size on request

Espositori

in alluminio
Soluzioni estetiche
e funzionali per Garden
Center.

Expositor

Our aluminum
exhibitors. Aesthetic and
functional solutions for all
Garden Centers.



KEOPE (Spalliera)

3 bench

- 0,44 x 3,0 m.
- 0,63 x 3,0 m.
- h. = 1,45 m.



INSERE (basket up)

- 1,12 x 2,31 m.
- h. = 1,5 m.



PERGIT (Alzata)

1 Bench

- 0,44 x 2,5 m.
- 0,63 x 2,5 m.
- h. = 0,7 m.



ADFIN (end line)

- 0,5 x 1,2 m.
- 0,5 x 1,6
- h. = 0,5 m.



Espositori Expositor

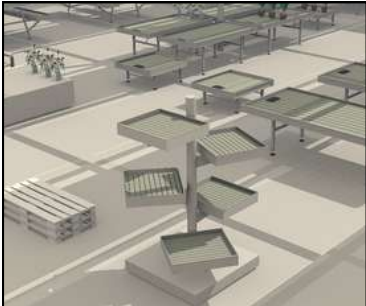

in alluminio
Soluzioni estetiche
e funzionali per Garden
Center

Our aluminum
exhibitors. Aesthetic and
functional solutions for all
Garden Centers.



CACTUS
(Fantasy multiplane)



- 1,28 x 1,28 m.
- h. = 1,85 m.







DESCO
(Display A4)

- 1,86 m.
- h. = 0,9 m.





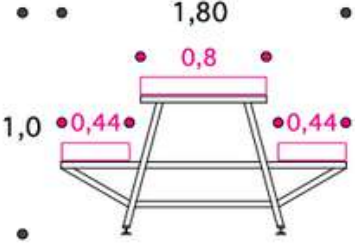

ARES

- 1 bench 0,80 x 3,0 m.
- 2 bench 0,44 x 3,0 m.
- h. = 1,0 m.





MAGNUM

- 1 bench 0,80 x 3,0 m.
- 4 bench 0,44 x 3,0 m.
- h. = 1,45 m.

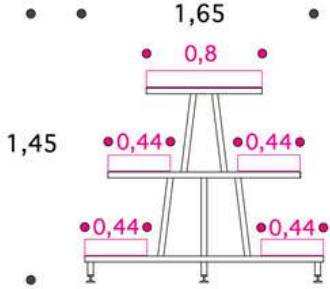

Optional Bench

Vasta gamma di accessori abbinabili a Bancali serie Bench e Bancali serie Produzione.

Wide range of accessories that can be combined with Tables from the Bench series and Tables from the Production series.



- Tappeti elettrici riscaldanti
- Electric heating mats



FLUSSO/RIFLUSSO SMART

Sistema a flusso e riflusso indipendente, abbinabile ai nostri Bench ed ad altre tipologie di bancali composto da:

- Serbatoio uso alimentare
- Pompa di sollevamento
- Valvola carico/scarico
- Programmatore elettronico



EBB/FLOW SMART

Independent ebb and flow system, combinable with our tables and other types of tables made up of:

- food use tanklift
- pumpFill/drain valve
- electronic programmer



KIT MICROCLIMA

Sistema di archetti per microclima/radicazione composto da:

- Staffe di fissaggio
- Tubi in alluminio
- Snodi e raccorderia
- Film plastico
- Maniglie alza/abbassa



MICROCLIMATIC SYSTEMS

Made arch system aluminum for microclimate/rooting composed of:

- fixing brackets Aluminum tubes Gaskets and gaskets plastic.
- film Raise/lower handles



Accessori Bench Accessories Bench

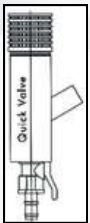
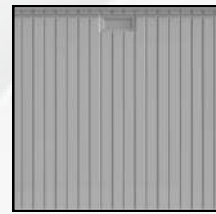
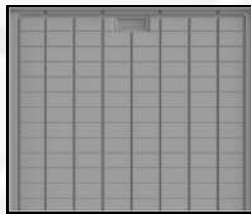
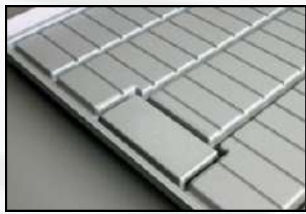
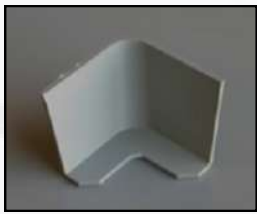
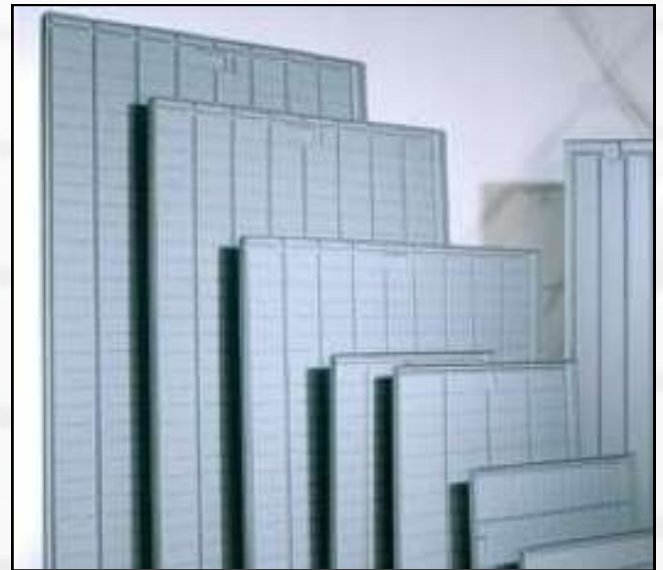

Quick valve

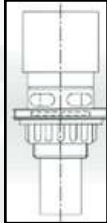

Siphon valve

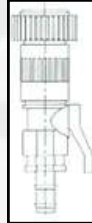

HS valve



ball valve

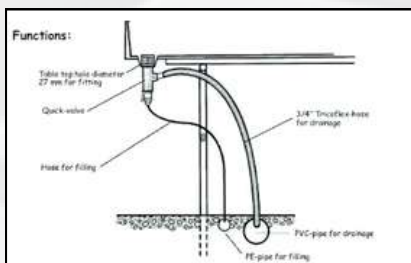
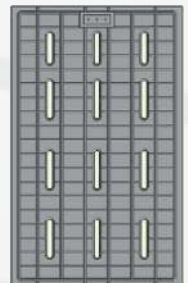
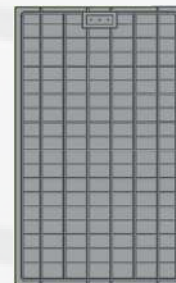

Sistemi flusso/riflusso
monotubo o bi tubo

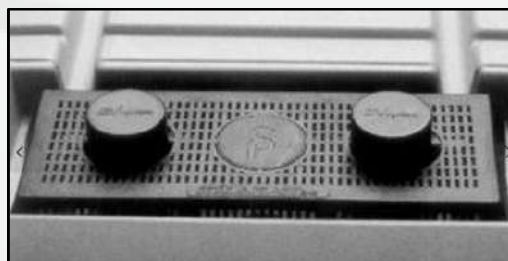

Ebb/Flow system
single pipe or double pipe



Return
valve



Produzione

Bancali da coltivazione fissi, mobili.

Containers system.

Aluminum benches fixed and mobile and Container system.



Progettazione, produzione, installazione di sistemi per coltivazione con bancali fissi, mobili ed estraibili (container system) chiavi in mano.



Design, production, installation of systems for cultivation with fixed benches, mobile and removable benches (container system) turnkey.



Flusso e riflusso

 I nostri sistemi a flusso/riflusso, automatici monotubo o a doppia linea.

Ebb/Flow systems

 Our automatic Ebb/Flow system single pipe or double pipe.

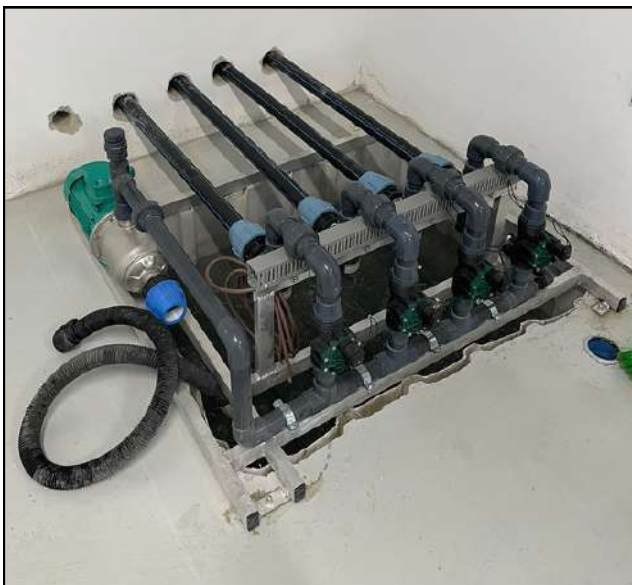
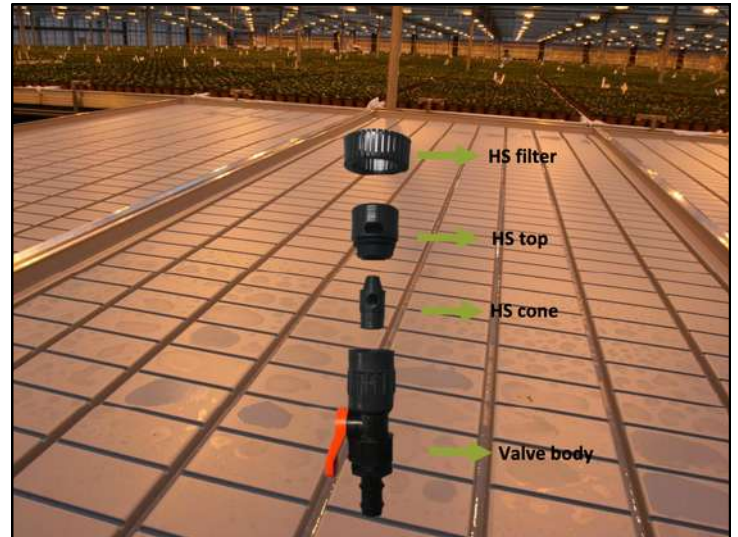
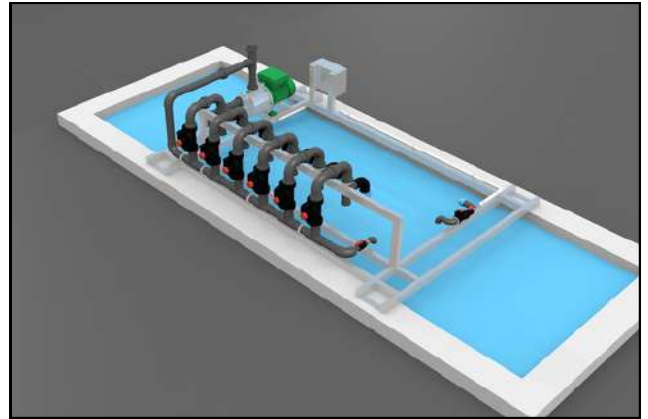



Fertirrigazione

- Impianti manuali da 3 a 90 mcH
- Impianti semi-automatici da 6 a 120 mcH
- Impianti automatici a controllo elettronico
- Acidificazione e correzione acque di irrigazione



Fertigation

- manual systems 3 / 90 mcH
- semi-automatic systems 6 / 120 mcH
- automatic electronically controlled systems
- acidification and correction of irrigation water

MORPHEUS



volumetrically controlled pumps

Pompe a controllo volumetrico



STAZIONI IDRICHE "CONNECT AND GO"





Raffrescamento comfort20

I nostri sistemi di raffrescamento per Garden center e serre di produzione.

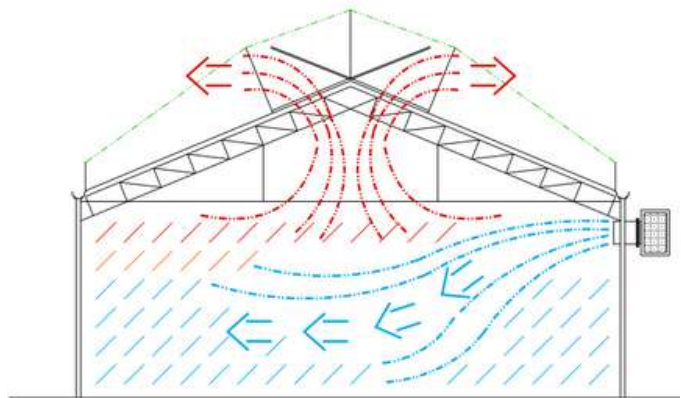

Cooling Systems comfort20

Our cooling systems for garden centers and production greenhouses.

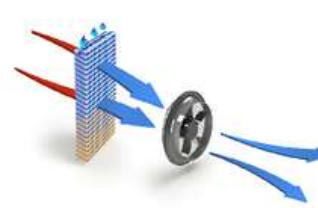

● NOVITA' !!!
NEW !!!

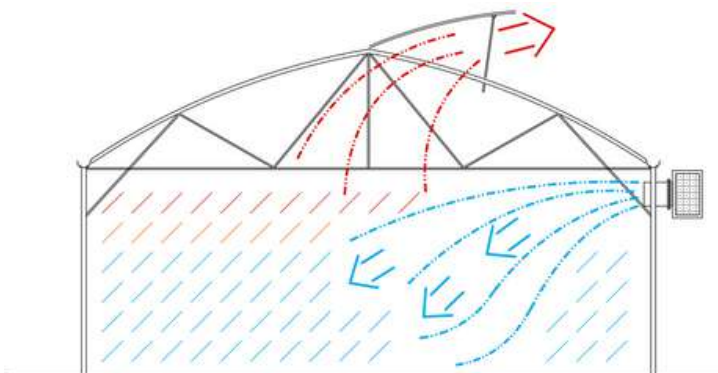
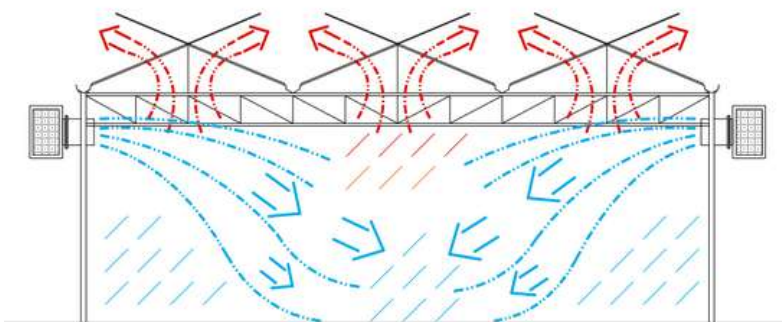



Vortici raffrescanti grecale20

E' un innovativo destratificatore per serre. Silenzioso, performante, indispensabile.
Disponibile in 2 modelli da 220V:
7.500 Mc/h - 10.000 Mc/h



Cooling vortices grecale20

It is an innovative destratifier for greenhouses. Silent, high performance, essential.
Available in 2 - 220V models:
7.500 Mc/h - 10.000 Mc/h

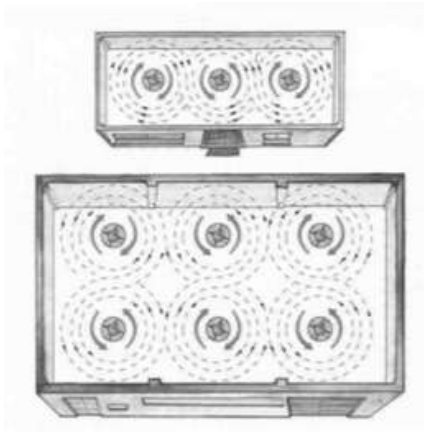
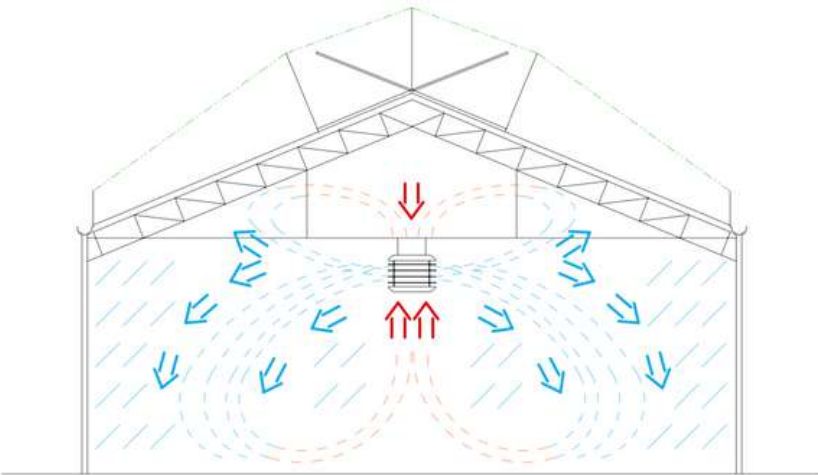

Hight performance

New design for Garden Center



Option
Black or white



●
NOVITA' !!!
NEW !!!



Impianti di riscaldamento

Progettazione ed installazione:

- Riscaldamento a tubi lisci
- Generatori d'aria calda
- Riscaldamento ad aerotermi
- Riscaldamento basale
- Centrali termiche



Heating systems

Design and installation:

- Smooth tube heating
- Hot air generators
- Hot air heating
- Basal warming
- Thermal power stations



BIOMASSA
GAS
GASOLIO
GPL





Impianti per colture in fuorisuolo

Progettiamo e realizziamo impianti per orticoltura in fuori suolo con le più avanzate tecnologie.



Plants for soilless cultivation

We design and create soilless horticulture systems with the most advanced technologies.



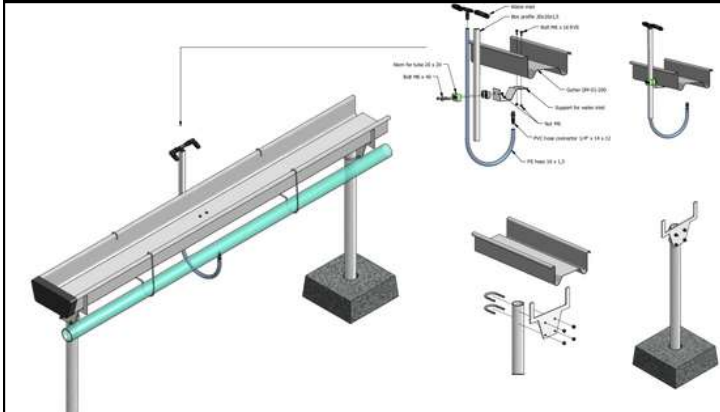

progetto 20

Greenhouse Facilities 



progetto20 S.r.l.

Sede Legale: Via San Quirino 40 - 39100 Bolzano -
P.IVA 03104040211 - Ph. +39 0471 972539

Filiale di Mantova: Via Parigi 20/22 - Ph. +39 0376.294522
46047 Porto Mantovano (MN) - M.Ph. +39 348.7977129

Filiale di Bergamo: Via Tribolina 28 - Ph. +39 035.0791921
24064 Grumello del Monte (BG) - M.Ph. +39 348.2618488

